

PRODUCT DATA SHEET

2024-02-02



Article number:

5612660433GS 

Fixed castor 125 mm, TPU-tyre

Fixed bracket made of zinc-chromatized pressed sheet metal. Top plate fitting. Wheel axle with nut. Wheel with grey TPU-tyre. Hub made of black Nylon/PA6 with threadguards. Ball bearing.



Image may differ from the actual product.*

DIMENSIONS

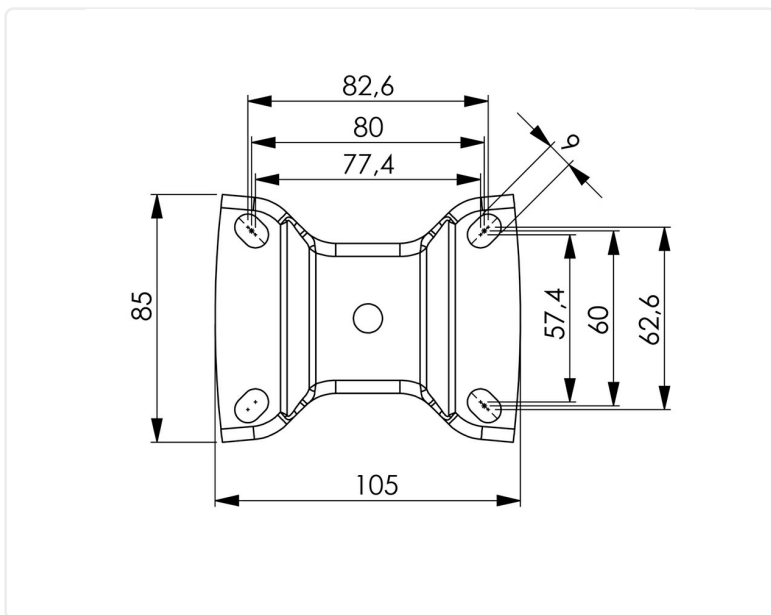

SPECIFICATIONS

Diameter	125 mm
Total height	157 mm
Load Capacity (dynamic)	225 kg
Castor model	Fix
Fitting	Top plate
Material Tread	Polyurethane
Bearing	Ball bearing
Plate Size	105x85 mm
CC Distance	80x60 mm
Thread hardness (Shore°)	98° Shore A
Width of tread	36 mm
Hub Hole Diameter	10 mm
Material Hub	Nylon PA6
Top Hole	12,5x9 mm
Fork Width	48 mm
Fixed	Yes
Color Tread	Grey
Material Type	RoHS (EU) - Approved
Teststandard	EN 12532
Material Thickness Bracket	2 mm
Material thickness plate	2 mm
Product Weight	0,77 kg
Temperature Range	-30°C to +70°C

Numeric values in the technical specification can be nominal/rounded to the nearest standard dimension. To see exact values, please use the drawing.